



WELCOME RAMADAN

By

\_\_\_\_\_

Allah tells us in the Qur'an...

وَمَا خَلَقْتُ الْجِنَّ وَالْإِنْسَ إِلَّا لِيَعْبُدُونِ

I created the jinn and humankind only that they might worship Me  
(Surah adh-Dhariyat ayah 56)

Allah created everything!  
Can you write some of the  
things Allah has created...

We do not worship  
anyone other than Allah.  
Allah Alone is the One  
who is worthy of all  
praise.  
It is only Allah Alone  
Whom we worship.  
Why did Allah create us?

---

---

---

رمضان

Ramadan

Ramadan is a special month! Let's find out why inshallah!

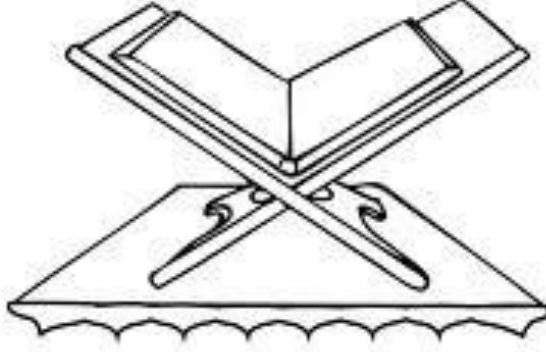

شَهْرُ رَمَضَانَ الَّذِي أُنزِلَ فِيهِ الْقُرْآنُ هُدًى لِّلنَّاسِ وَبَيِّنَاتٍ مِّنَ الْهُدَىٰ وَالْفُرْقَانِ فَمَن  
شَهِدَ مِنْكُمُ الشَّهْرَ فَلْيَصُمْهُ وَمَن كَانَ مَرِيضًا أَوْ عَلَىٰ سَفَرٍ فَعِدَّةٌ مِّنْ أَيَّامٍ أُخَرَ يُرِيدُ اللَّهُ  
بِكُمُ الْيُسْرَ وَلَا يُرِيدُ بِكُمُ الْعُسْرَ وَلِتُكْمِلُوا الْعِدَّةَ وَلِتُكَبِّرُوا اللَّهَ عَلَىٰ مَا هَدَاكُمْ  
وَلَعَلَّكُمْ تَشْكُرُونَ

Ramadan is the (month) in which was sent down the Qur'an as a guide to mankind also clear (Signs) for guidance and judgment (between right and wrong). So everyone of you who is present (at his home) during that month should spent it in fasting, but if anyone is ill, or on a journey, the prescribed period (should be made up) by days later. Allah intends every facility for you He does not want to put you to difficulties. (He wants you) to complete the prescribed period, and to glorify Him in that He has guided you; and perchance ye shall be grateful.

Surah al Baqarah ayah 185

# 5 pillars of Islam

Narrated Ibn Umar:

Allah's Messenger ﷺ said:

"Islam is based on five principles:

1. To testify that none has the right to be worshiped but Allah and that Muhammad is the Messenger of Allah. (Shahadah)
2. To perform Salat.
3. To pay Zakat.
4. To perform the Hajj.
5. To observe Saum during the month of Ramadan."

Sahih Al-Bukhari Book of Revelation,  
Chapter 2, Hadith #8

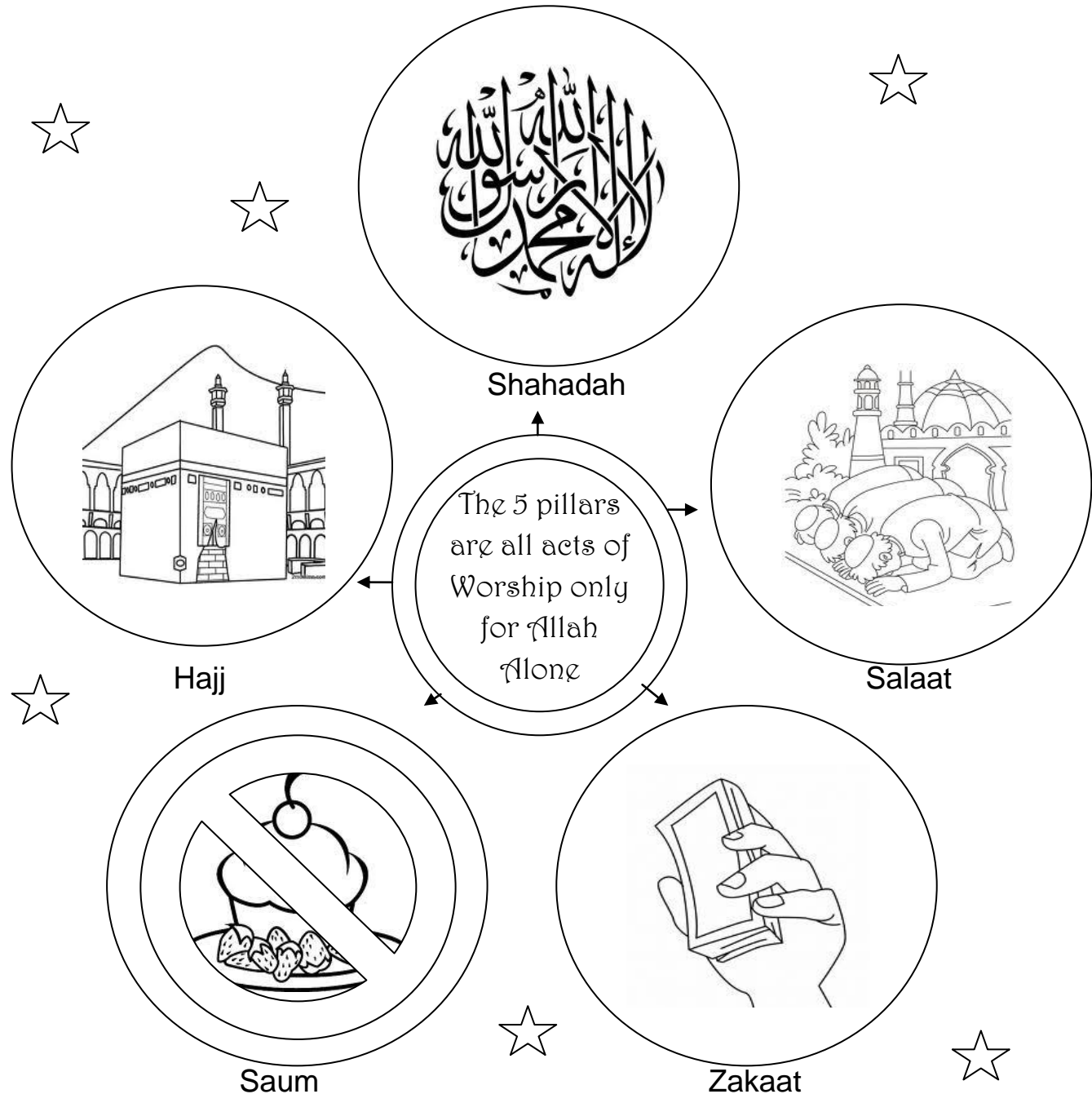

# Pillars of Islam

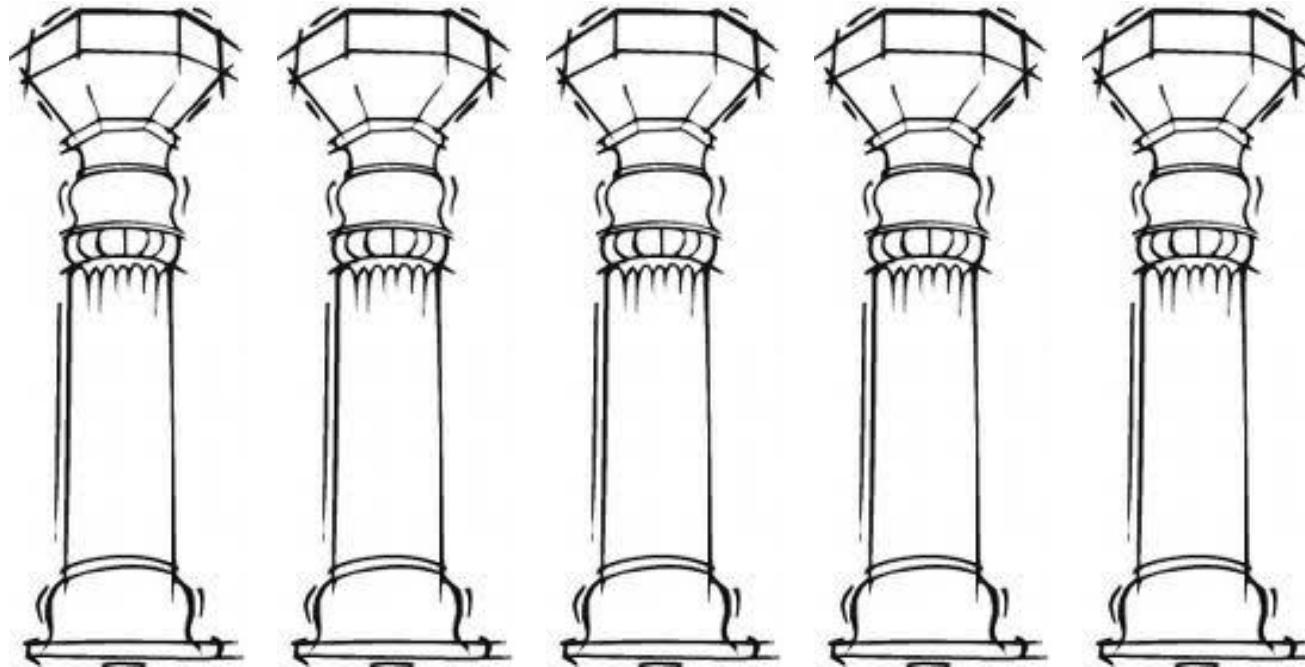

Shahadah

Salaah

Zakaah

Saum

Hajj

Saum in Ramadan is one of the pillars of Islam. Saum means to fast, which is to not eat or drink. Let's find out more on the next page inshallah!

# Islamic Months

1. Muḥarram المحرم
2. Ṣafar صفر
3. Rabī' al-Awwal ربيع الأول
4. Rabī' ath-Thānī ربيع الثاني
5. Jumādā al-Ūlā جمادى الأولى
6. Jumādā ath-Thāniya جمادى الثانية
7. Rajab رجب
8. Sha'bān شعبان
9. Ramaḍān رمضان
10. Shawwal شوال
11. Dhū al-Qa'da ذو القعدة
12. Dhū al-Ḥijja ذو الحجة

What is the 9<sup>th</sup>  
Islamic month?

Write the Islamic months in your best handwriting.....

- 1) \_\_\_\_\_
- 2) \_\_\_\_\_
- 3) \_\_\_\_\_
- 4) \_\_\_\_\_
- 5) \_\_\_\_\_
- 6) \_\_\_\_\_
- 7) \_\_\_\_\_
- 8) \_\_\_\_\_
- 9) \_\_\_\_\_
- 10) \_\_\_\_\_
- 11) \_\_\_\_\_
- 12) \_\_\_\_\_

# How do we fast?

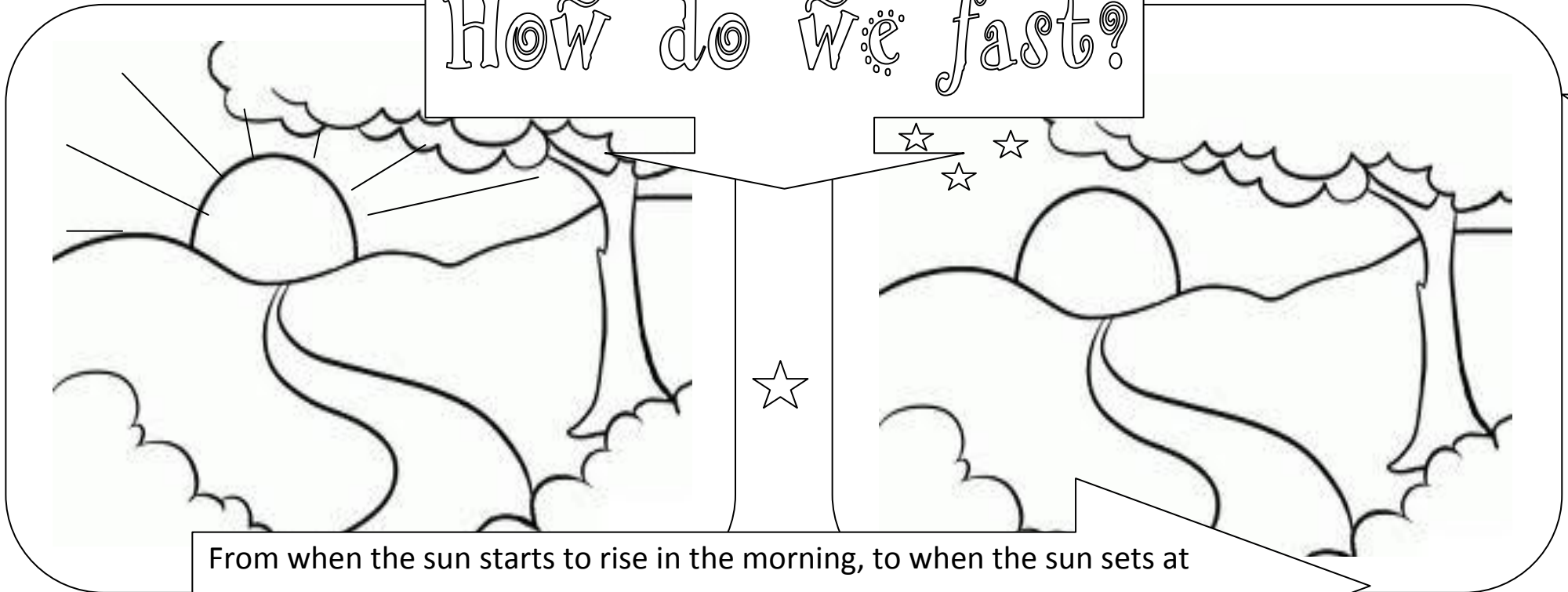

From when the sun starts to rise in the morning, to when the sun sets at Night, we do not eat or drink during the month of Ramadan!

Handwriting practice scroll with three horizontal lines.

Copy the sentence explaining when we fast onto the scroll above in your best handwriting!



# Sahur

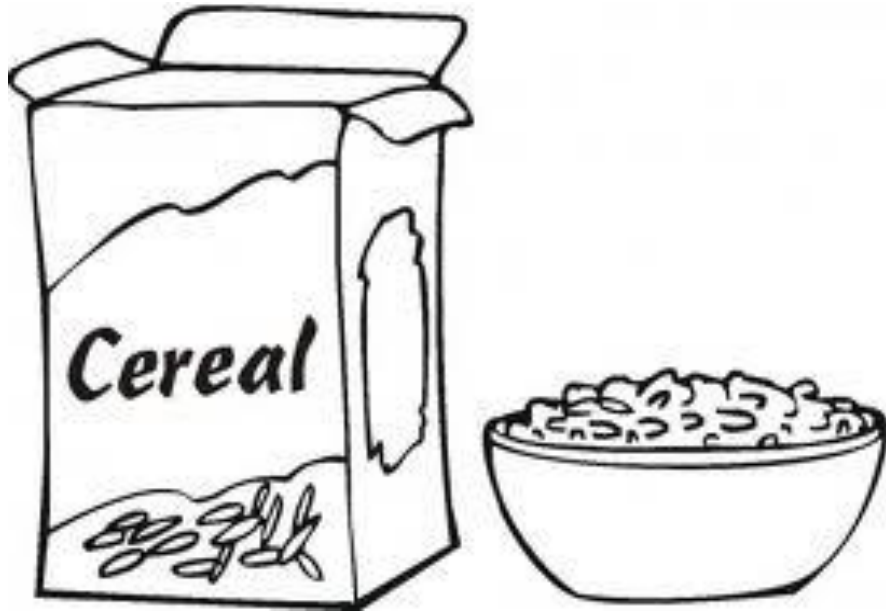

**Narrated Anas bin Malik: The Prophet ﷺ said:**  
**"Take Sahur as there is a blessing in it."**

Sahih al Bukhari,  
The Book of As-Saum hadeeth #1923

Sahur is a special meal eaten before the sun rises late at night...like a very early breakfast!

The Prophet Muhammad ﷺ has told us there is a blessing in eating Suhur.

After the sun starts to rise at dawn, we cannot eat or drink until the evening, so eating Suhur will help our body to have energy inshallah!

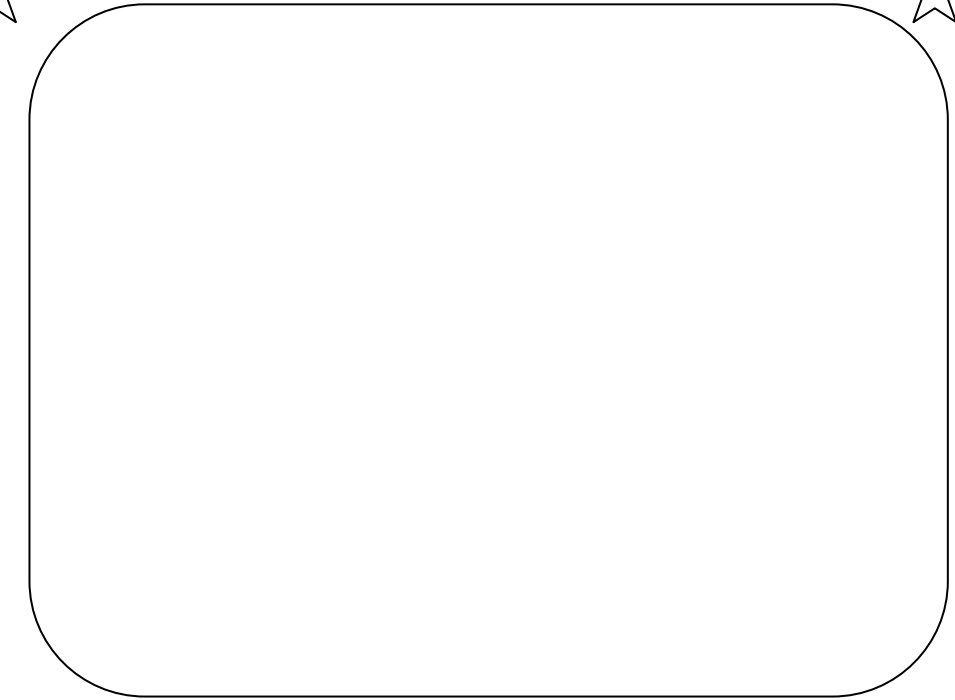

Draw a picture of what you would like to eat for Suhur.

# if you forget...

If you forget that you are fasting, and you eat or drink something by mistake, then do not worry! Alhamdulillah Allah is the Most Merciful, and you can continue your fast without having broken it. But you must not eat anything else as soon as you remember!

What should you do if you forget you are fasting and you eat or drink something?

---

---

---



**Narrated Abu Hurairah: The Prophet ﷺ said: "If somebody eats or drinks forgetfully, then he should complete his Saum (fast), for what he has eaten or drank has been given to him by Allah."**

Sahih al Bukhari The Book of As-Saum  
Hadith # 1933

# What ruins your fast?

Back-biting,  
lying and being  
rude

Eating on  
purpose

Drinking on  
purpose

Some things will ruin your fast,  
so it is important to know what  
they are so that you know not to  
do them!

Match the pictures to the  
sentences by drawing a line.



Did you know  
what she did?

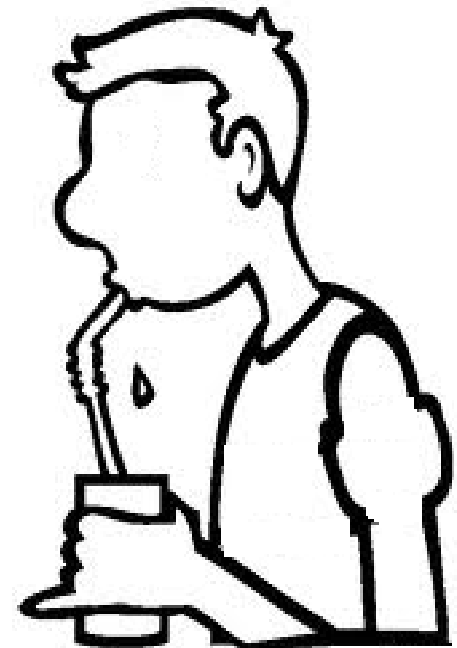

# A Muslim speaks only good!

Abu Hurairah reported: The Prophet ﷺ said: "If one does not eschew lies and false conduct, Allah has no need that he should abstain from his food and drink"

Sahih al Bukhari, Riyad-Us-Saliheen hadith # 1241

Abu Hurairah reported: The Messenger of Allah ﷺ said: "When any one of you is observing Saum (fasting) on a day, he should neither indulge in obscene language nor should he raise the voice; and if anyone reviles him or tries to quarrel with him, he should say: "I am observing fast"

Sahih al Bukhari & Muslim, Riyad-us-Saliheen hadith # 1240

We are always commanded to keep away from bad and rude behaviour, and to be good and kind to others. In Ramadan it is even more important!

Why do you think it is so important to speak nicely to people and to not talk about them in a bad way?

---

---

---

---

---

What did the Prophet ﷺ tell us to do if someone tries to be rude or argue with us?

---

# iftar

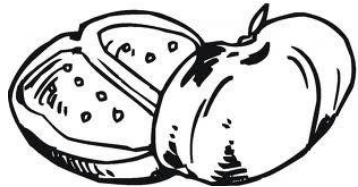
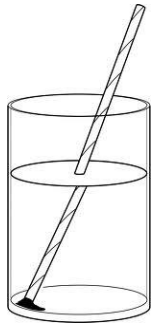

Salam bin 'Amir narrated that the Messenger of

Allah ﷺ said:

**“When any one of you breaks his fast, let him break it with dates. If he cannot find dates, then let him break it with water, for it is a means of purification”**

(Sahih)

Sunan Ibn Majah

Chapter on what has been narrated concerning fasting,

Hadeeth # 1699

At the end of the day when the fast is over and we can start to eat again, the Prophet

Muhammad ﷺ advised us to break our fast with dates or water.

If however we don't have dates or water available, then any food or drink can be used instead.

Draw a picture of what you would like to eat after breaking fast

# Dua' at the time of breaking fast

ذَهَبَ الظَّمَاُ ، وَ ابْتَلَّتِ العُرُوْقُ وَ ثَبَتَ الأَجْرُ إِنْ شَاءَ اللهُ

The thirst is gone, and the veins are quenched, and the reward is assured, if Allah wills

At the time of breaking our fast, when we are about to eat, there is a dua'a we can say, just as the Prophet Muhammad ﷺ did.

The Prophet ﷺ used to say when breaking his fast: ***"The thirst is gone, and the veins are quenched, and the reward is assured-if Allah wills"***.

Sunan Abu Dawud, The book of Fasting, hadeeth # 2357

Can you read the Arabic dua'a above and its meaning inshallah?



# Qiyam ul Layl

During the night we can offer extra salaah and this is called Qiyam-ul-Layl or Tahajjud, and in the month of Ramadan some people call it Tarawih.

Qiyam means “Standing” and Qiyam-ul-Layl means “Standing at night”. It is called Standing because long portions of Qur’an are recited during the salaah.

The Prophet Muhammad ﷺ has told us that if we offer salaah at night during the month of Ramadan, only for Allah and hoping Allah will reward us, then our sins will be forgiven! SubhanAllah!

What does Qiyam ul-Layl mean?

---

Why does it mean this?

---

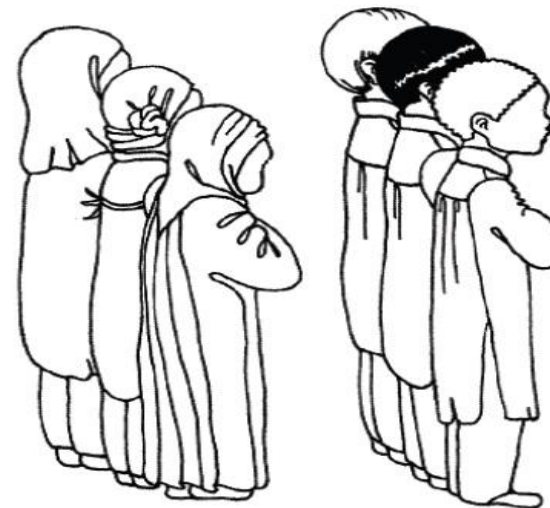
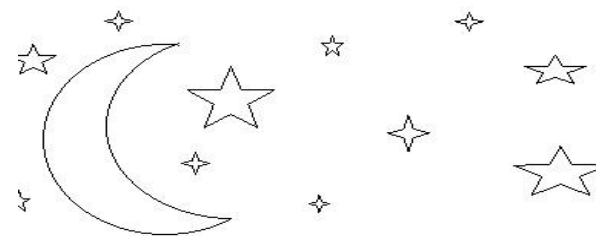

Narrated Abu Hurairah: I heard Allah’s

Messenger ﷺ saying regarding Ramadan, “Whoever performed salat at night in it (Ramadan) with sincere faith and hoping for a reward from Allah, then all his past sins will be forgiven.”

Sahih al Bukhari The book of as-Saum  
hadith # 2008

Design a mat...you could use felt tips and pencils to colour, or even stick bits of paper or material...its up to you!





# Laylat ul-Qadr

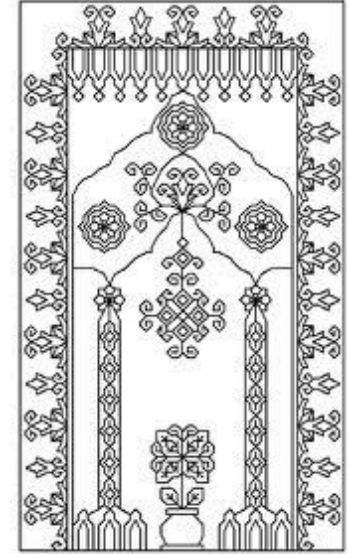
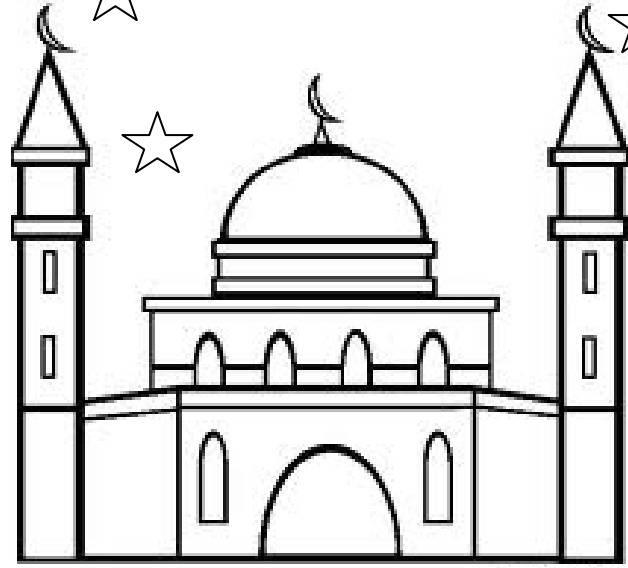
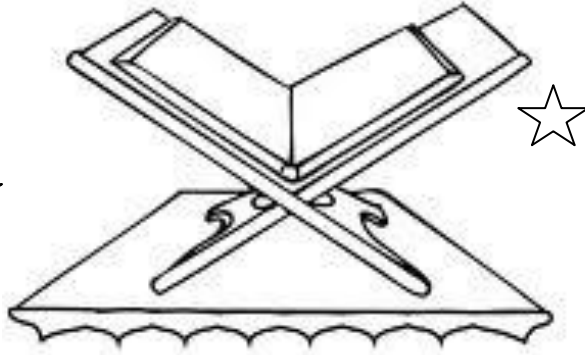

بِسْمِ اللَّهِ الرَّحْمَنِ الرَّحِيمِ

إِنَّا أَنْزَلْنَاهُ فِي لَيْلَةِ الْقَدْرِ (١) وَمَا أَدْرَاكَ مَا لَيْلَةُ الْقَدْرِ (٢) لَيْلَةُ الْقَدْرِ خَيْرٌ مِّنْ أَلْفِ شَهْرٍ (٣)  
تَنْزِيلُ الْمَلَائِكَةِ وَالرُّوحِ فِيهَا بِإِذْنِ رَبِّهِمْ مِّنْ كُلِّ أَمْرٍ (٤) سَلَامٌ هِيَ حَتَّىٰ مَطَلَعِ الْفَجْرِ (٥)

In the name of Allah, the Beneficent, the Merciful

We have indeed revealed this (Message) in the night of Power: (1) And what will explain to thee what the Night of Power is? (2) The Night of Power is better than a thousand Months. (3) Therein come down the angels and the Spirit by Allah's permission, on every errand: (4) Peace!... This until the rise of Morn! (5)

Laylat ul-Qadr is a very special and blessed night! It is the best night of Ramadan, in fact it is the best night of the whole year!  
Allah tells us this night is better than 1000 months!

The exact date of Laylat ul Qadr is not known, but the Prophet Muhammad told us to search for it in the last 10 nights of Ramadan.



Pretend to write to a friend, to tell them something about Laylat ul-Qadr.....

---

---

---

---

---

---

---

---

---

---

On this night Allah rewards us even more for our acts of Ibadah (worship)! We should do our best to worship Allah as much as we can, hoping for His reward!



# E'id ul Fitr

At the end of Ramadan is a big celebration, E'id ul Fitr! This is a special time and we gather together to pray Salaat ul E'id!



How do you and your family spend E'id?

---

---

---

---

---

---

---

---

---

---

Use this page to write what you have learnt about Ramadan! You can draw some pictures too!

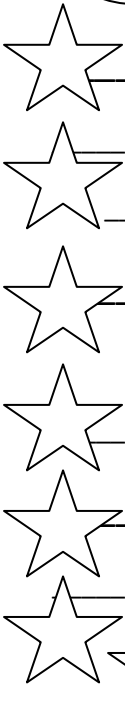
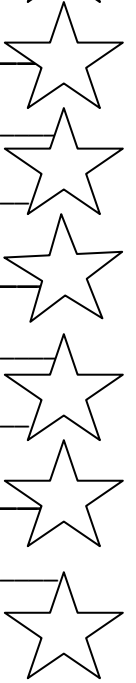
A large, empty rounded rectangle with a thin black border, intended for drawing or writing.A series of seven horizontal lines extending from the right side of the large rounded rectangle, providing space for writing.A large, empty rounded rectangle with a thin black border, intended for drawing or writing.